



Judah[®]Steel
A VISION IS BORN

KEY-LOCK[®]

CONCEALED CEILING SYSTEMS



INSTALLATION GUIDE

Judah key-lock®

CONCEALED CEILING SYSTEMS

INTRODUCTION

Whether you're looking to direct fix or fully suspend your plasterboard ceiling, the Judah KEY-LOCK® Concealed Suspended Ceiling System is designed to produce a high-quality structure for a flawless, flush or featured finish. The KEY-LOCK® system can also be used as a framework to line virtually any existing wall or substrate.

It's our most popular and superior ceiling system as it is available for fire-rated, bulkhead, seismic and acoustic designs, as well as having the strength to hold multiple layers of plasterboard.

SUITABLE FOR

- Flush plasterboard ceilings
- Direct Fix or Fully Suspended applications
- Non-Fire Rated systems
- Fire Rated systems
- Acoustic Systems available (by design)
- Seismic Systems available (by design)

SPECIAL FEATURES

- Able to be designed for external use, for example External Soffits
- Base material engineered from G2 BlueScope Steel for strength and reliability
- Primary and secondary profiles available in custom lengths or radiusses

WHY USE KEY-LOCK®

The components within the system have been specially designed so that they simply snap into sections, without mechanical tools being required. This means it's easy to install and speeds up time on site.

Top Cross Rail and Furring Channel sections have rolled edges to make them safer to handle and with our state-of-the-art manufacturing processes, we can also produce these profiles in custom lengths or radiusses for vaulted and curved ceilings.

Our KEY-LOCK® Ceiling System can also be installed with our Acoustic Mounts to improve airborne sound and impact sound transmitted between floors, which is particularly important in multi-residential projects.

Note that this brochure is intended to be used as a guide only; full details should be obtained from the Judah website. All products in this brochure are for internal use only unless otherwise indicated. Judah recommends installation by a qualified tradesperson and that you ensure you are referring to the latest version of this guide by comparing it to the one on our website.

VARIOUS KEY-LOCK® COMPONENTS



121



127

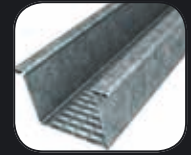

129

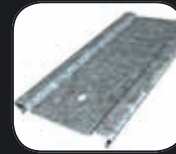

138



139



140



142



167



226



237



272



301

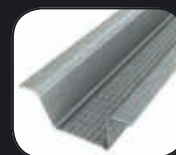

303



305



308



314



315



333



394

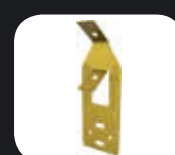

534



2534

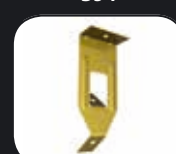

547

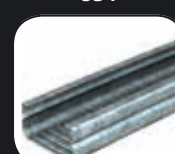

B005



BG01



BG02

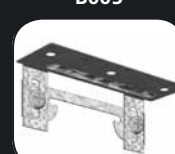

FC-INFIN0030

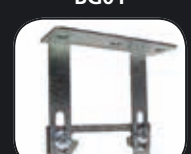

FC-INFIN0080

Judah key-lock®

INSTALLATION DETAILS

- 1 **SPACINGS**
Table 1 has been prepared for a batten spacing of 24". Confirm with your lining distributor that this spacing is suitable for your lining board selection.
- 2 **SELECTION**
Choose the most appropriate Batten or Furring Channel to suit your lining board.
- 3 **DIRECT FIX AND INSTALL**
Refer to Figures 1– 4 for the direct fix clip relevant for your batten/furring channel choice.
- 4 **SUSPENDED CEILINGS**
If your ceiling needs to be suspended by more than 200mm, refer to the next page.

TABLE 1: SPAN TABLE FOR INTERNAL USE IN POPULATED RESIDENTIAL AREAS

BATTEN/FURRING CHANNEL	600mm SPACINGS	
	PLASTERBOARD LINING	
	1 x 3/8"	1 x 5/8"
301/303	48"	48"
129	62"	60"
308	48"	49"

NOTE: For help with quantity take-offs, use the Judah Ceiling Design Wizard by downloading the Judah App or visiting our website.

DIRECT FIX INSTALLATION

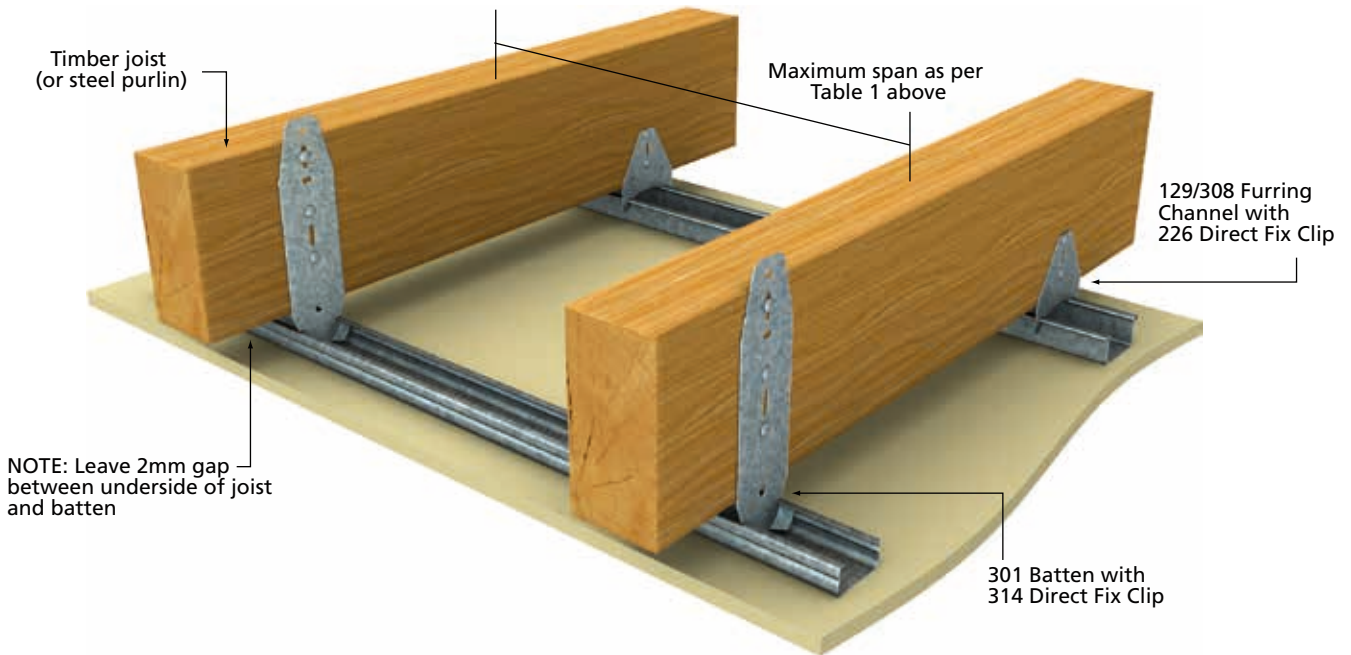

FIGURE 1: DIRECT FIX APPLICATIONS USING STANDARD Judah COMPONENTS

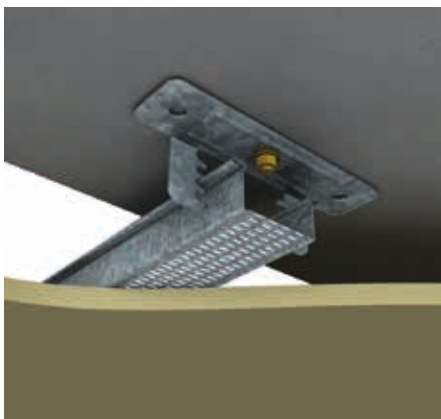

FIGURE 2: DIRECT FIX APPLICATION BENEATH CONCRETE SLAB USING BG01 CLIP AND ONLY INSTALLED WITH A CENTRE FIX

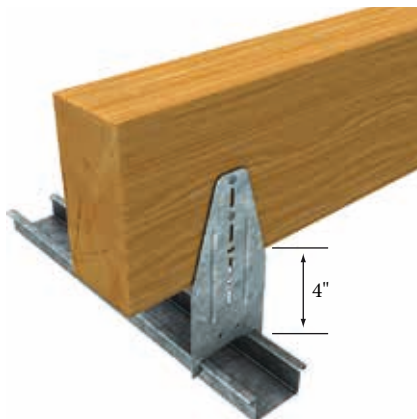

FIGURE 3: SUSPENDED APPLICATION USING 129/308 FURRING CHANNEL WITH 394 DIRECT FIX CLIP

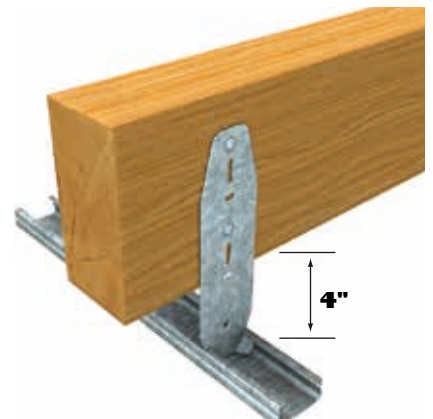

FIGURE 4: DIRECT FIX CLIP 305 IN SUSPENDED APPLICATION TO A RECOMMENDED MAXIMUM OF 4" FOR 301 BATTEN

SUSPENDED CEILING INSTALLATION

For ceilings with more than 200mm suspension depth, a fully suspended system should be installed.

1. Fix Judah 140 Wall Track (or 142 Wall Track if using the 308) around the perimeter of the ceiling
2. Secure hanger clips at a 48" x 48" grid pattern ensuring the first Top Cross Rail is located within 200mm of abutting walls. If using multiple layers of plasterboard consult the Judah Professional Design Manual.
3. Cut 121 Suspension Rod to required length and slide into hanger clip tabs. Refer Figure 6.
4. Slide 2534 Clip onto the other end of the rod.
5. Secure 127 Top Cross Rail to the 2534 Clips with a twisting action. Fit 139 Joiner Clips to Furring Channel
6. Secure Furring Channel to Top Cross Rail at a maximum of 24" apart or at appropriate spacings for your lining choice, ensuring 5–10mm clearance is left between end of Furring Channel and wall.
7. Framing can be leveled by adjusting the 2534 Clip by squeezing tabs together.
8. See illustrations below for fixing and bracing details.

NOTE:
Distance between hangers supporting TCR = span of TCR

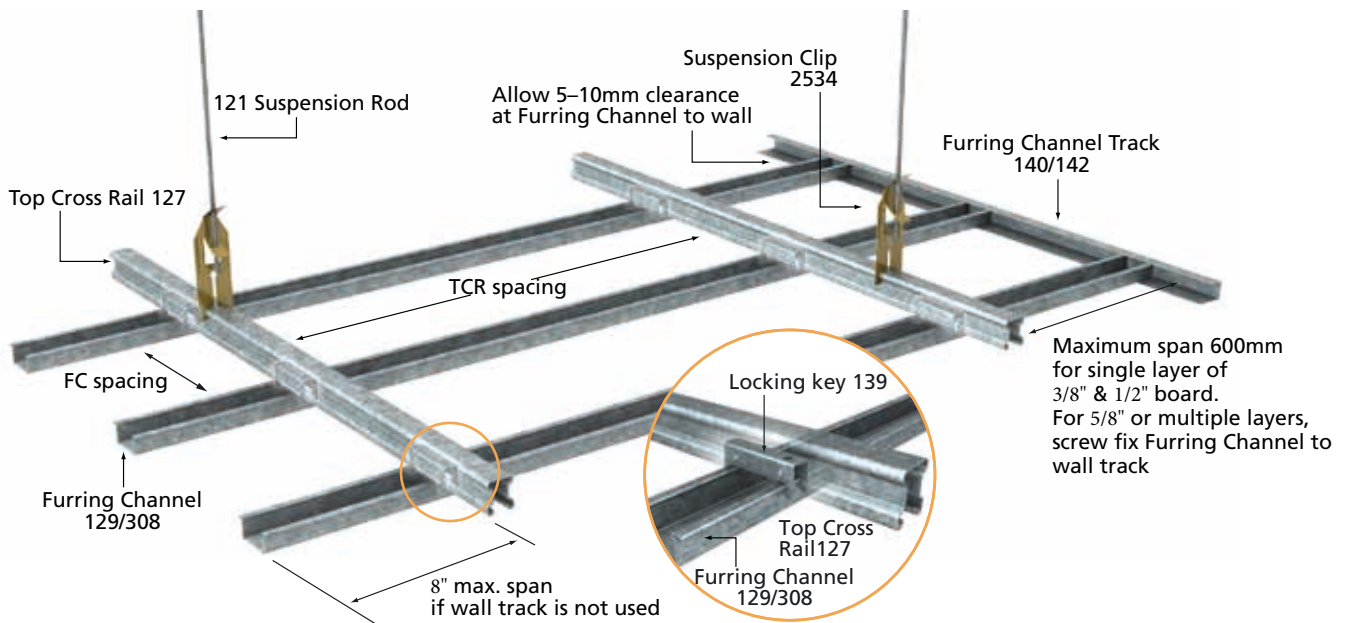

FIGURE 5: KEY-LOCK® SUSPENDED CEILING

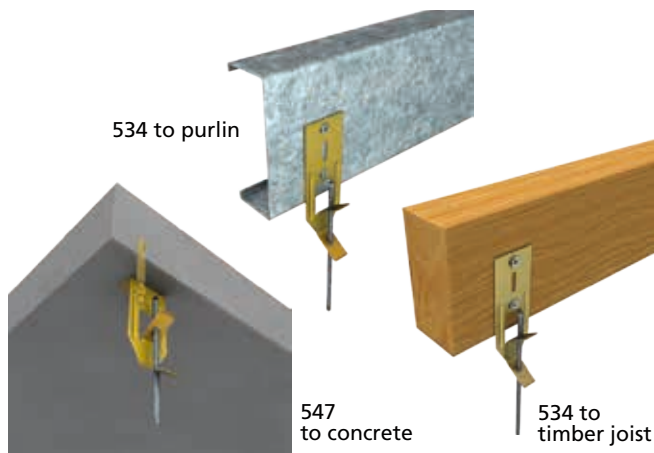

FIGURE 6: HANGER CLIPS

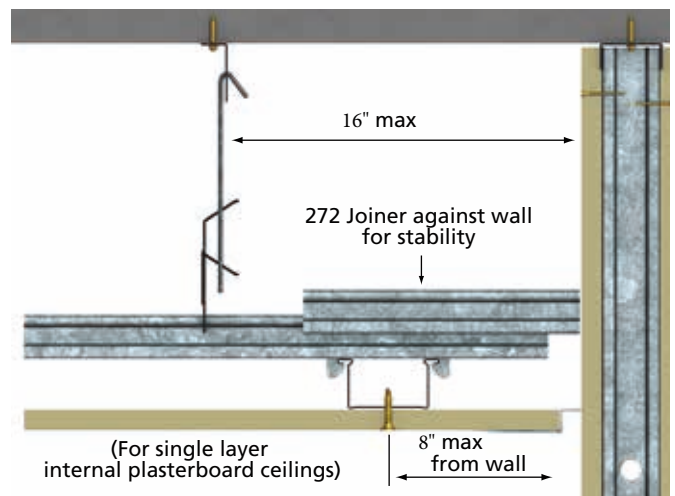

FIGURE 7: STABILISING THE SYSTEM

For more complex technical details, view the Judah Professional Design Manual or speak to a stockist in our Judah Partner Network. Download a copy of the Manual and locate a Judah Partner by visiting our website. For board fixing details, please see the plasterboard manufacturer.

MASONRY WALL INSTALLATION

Judah Furring Channels and adjustable clips are the ideal combination for battening out irregular walls, ready for the fixing of building boards.

1. INSTALL CLIPS

Fix the adjustable BetaGrip® Clips to the masonry wall as figure 8 inset using either "knock-in" anchors or plugs and screws. For timber framed wall use suitable screws. (See note on fixing alternatives for BetaGrip® Clips).

2. ATTACH FURRING CHANNEL

The BetaGrip® Clip has 'notches' to accept the furring channel, these are spaced approx 5mm apart.

Selecting the appropriate notch and using a rolling action clip the 129 or 308 Furring Channel into place.

Check the first Furring Channel for plumb and straightness and using this as a guide install the remaining Furring Channels. For more minute adjustment of the clips for plumb etc., gently tap the prongs of the clip with a hammer to adjust.

3. FIX PLASTERBOARD

Screw fix plasterboard, tape and set joints and sand off as lining manufacturers recommendations.

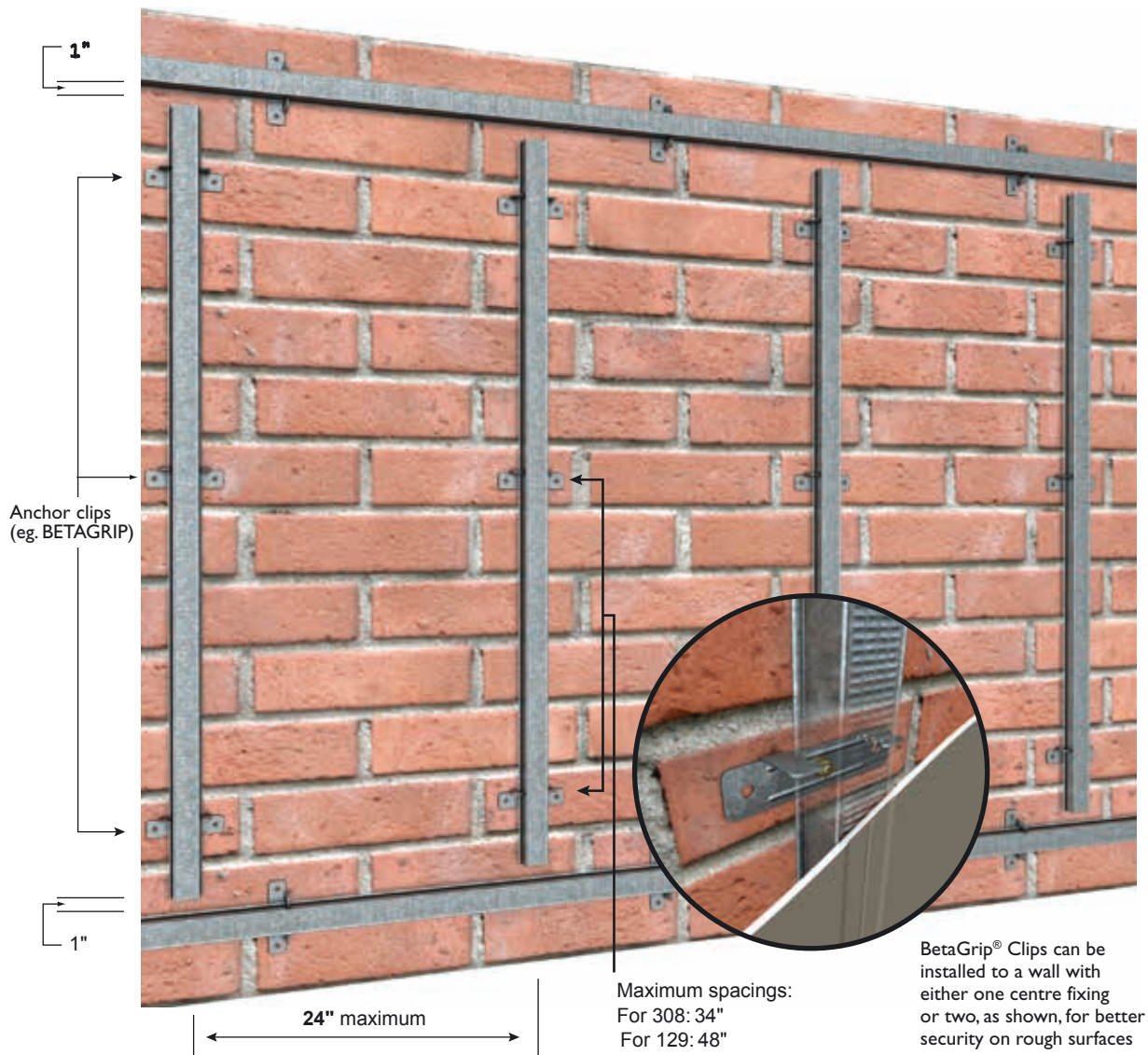

■ FIGURE 8: KEY-LOCK® USED TO BATTEN-OUT MASONRY WALL

Judah Services

MUCH MORE THAN JUST QUALITY PRODUCTS

We go beyond supplying you with quality products. We give you access to a full suite of tools and services to help you get the job done right and with the confidence that we'll support you every step of the way.

- ✓ **TECHNICAL SUPPORT** We offer expert technical advice from our team of professional Engineers and Technical Representatives who can support you from beginning concepts all the way through to building completion.
- ✓ **WRITTEN WARRANTY** Our products are 100% code compliant and we guarantee that they'll perform to our exacting specifications with a written warranty to give you added peace of mind.
- ✓ **PRODUCT QUALITY** Our state-of-the-art manufacturing technology ensures you receive the highest quality product, with most of our roll-formed products manufactured from the strength of BlueScope Steel.
- ✓ **QUALITY CONTROL** We have a reputation for uncompromising quality and total code compliance. Our certification to internationally recognised, Lloyd's Register Quality Assurance ISO 9001 is evidence of this.
- ✓ **DELIVERY SERVICE** We offer a reliable and efficient delivery service, with products delivered in full and on time whether it is on site or to store.
- ✓ **TECHNICAL RESOURCES** We've developed market-leading technical resources that are available in print and digitally to help you get the job done.
- ✓ **REPUTATION** It's our reputation for high-quality products backed by exceptional customer service that has led to us being behind the best buildings around the world. It's a reputation you can rely on.
- ✓ **ENVIRONMENTAL PERFORMANCE** We can offer you additional Green Points due to our participation in the Environmental Sustainability Charter and our Environmental Management System is accredited to ISO14001.
- ✓ **CORPORATE SOCIAL RESPONSIBILITY** Through purchasing Judah products, you are also supporting local communities we give back to. We're focused to help kids with cancer, with our main partner, The Kids Cancer Project. Their goal is to reduce the rate of childhood cancer through funded research initiatives.

